

Uma publicação da

MBIGUCCI

Construindo uma vida melhor

www.mbigucci.com.br

Brincando com o **BIGUCCINO**

Ano 8 - nº 8 - Dezembro / 2010

Atividades infantis para aprender, brincar e se divertir!

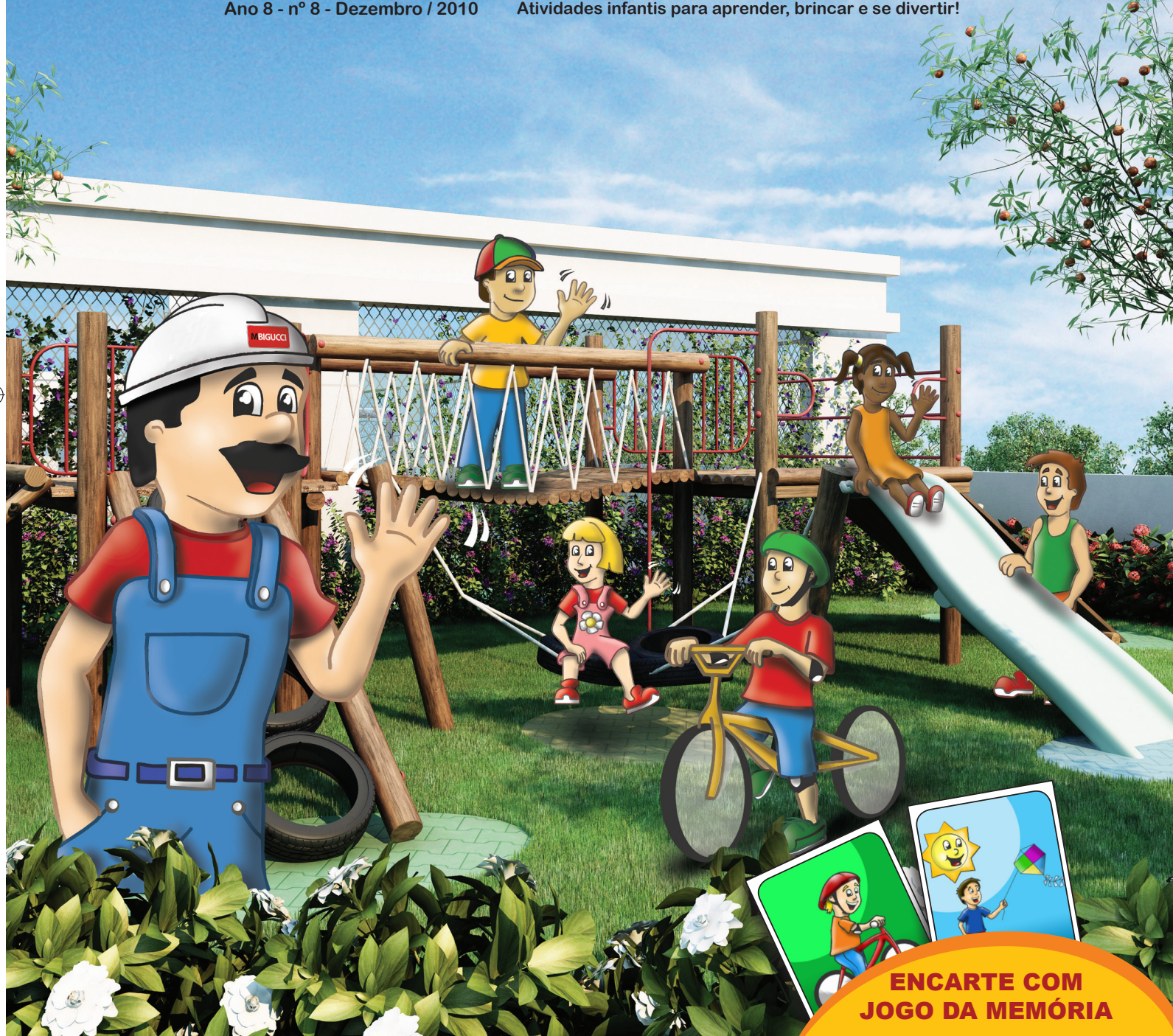

**ENCARTE COM
JOGO DA MEMÓRIA**

**CRUZADINHA • LABIRINTO • 7 ERROS
JOGO DAS SOMBRAS • CAÇA-PALAVRAS E MUITO MAIS!**



Olá Amiguinho! Hoje, além de brincarmos muito, vamos também aprender como evitar acidentes. Com alguns cuidados e ajuda dos seus pais é possível se divertir de forma bem segura!

Caça-Palavras

Á Ç R Y R E H P Ç A I Á R T A Y K ã U
 Y È R A A H M F A G O Z A Z I Á L A C
 S E M Á F O R O D E P E D E S T R E A
 Ç A P B A O R U T X V Ç B N M Y O P P
 À R F A I X A D E S E G U R A N Ç A A
 U O A D A Á I B K L A R Y O Ç A O M C
 A J O E L H E I R A B A U A M K U I E
 M N B T C X Z L K J H G F D S A P ã T
 M A R E D E D E P R O T E Ç ã O T O E
 Q ã E R T Y U I I O P A S D F G H J Ç
 C O L E T E S A L V A V I D A S K P I
 U A H E S I O P C O T O V E L E I R A

Encontre sete palavras que ajudam a ter uma diversão segura:

- 1 - Capacete
- 2 - Joelheira
- 3 - Cotoveleira
- 4 - Colete salva-vidas
- 5 - Faixa de segurança
- 6 - Semáforo de pedestre
- 7 - Rede de proteção





Vamos colorir?

Use sempre colete salva-vidas na praia, piscina ou para passear de barco e não se esqueça de pedir para um adulto ficar sempre por perto.

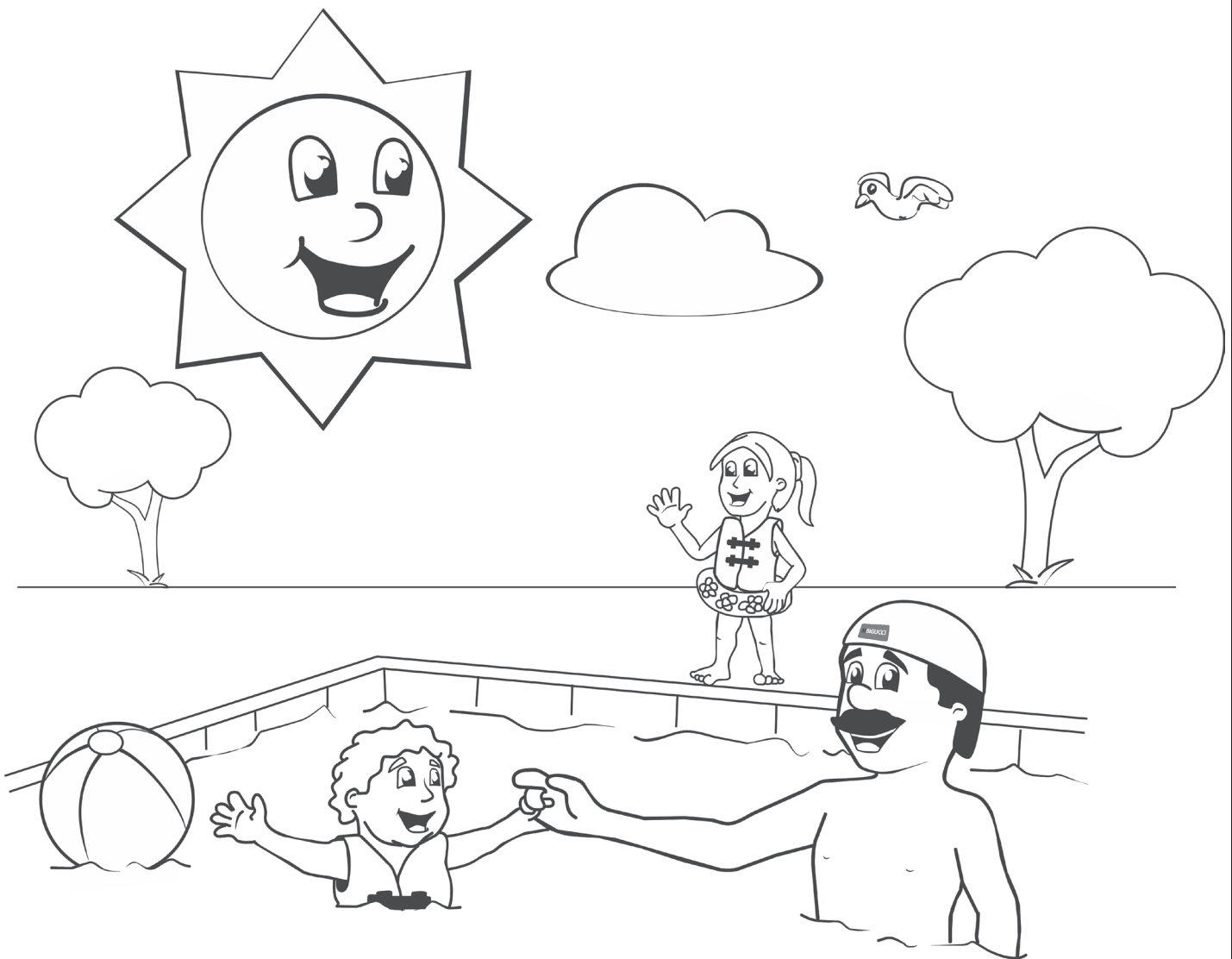



Labirinto

Empine pipas somente longe de postes e fios elétricos!

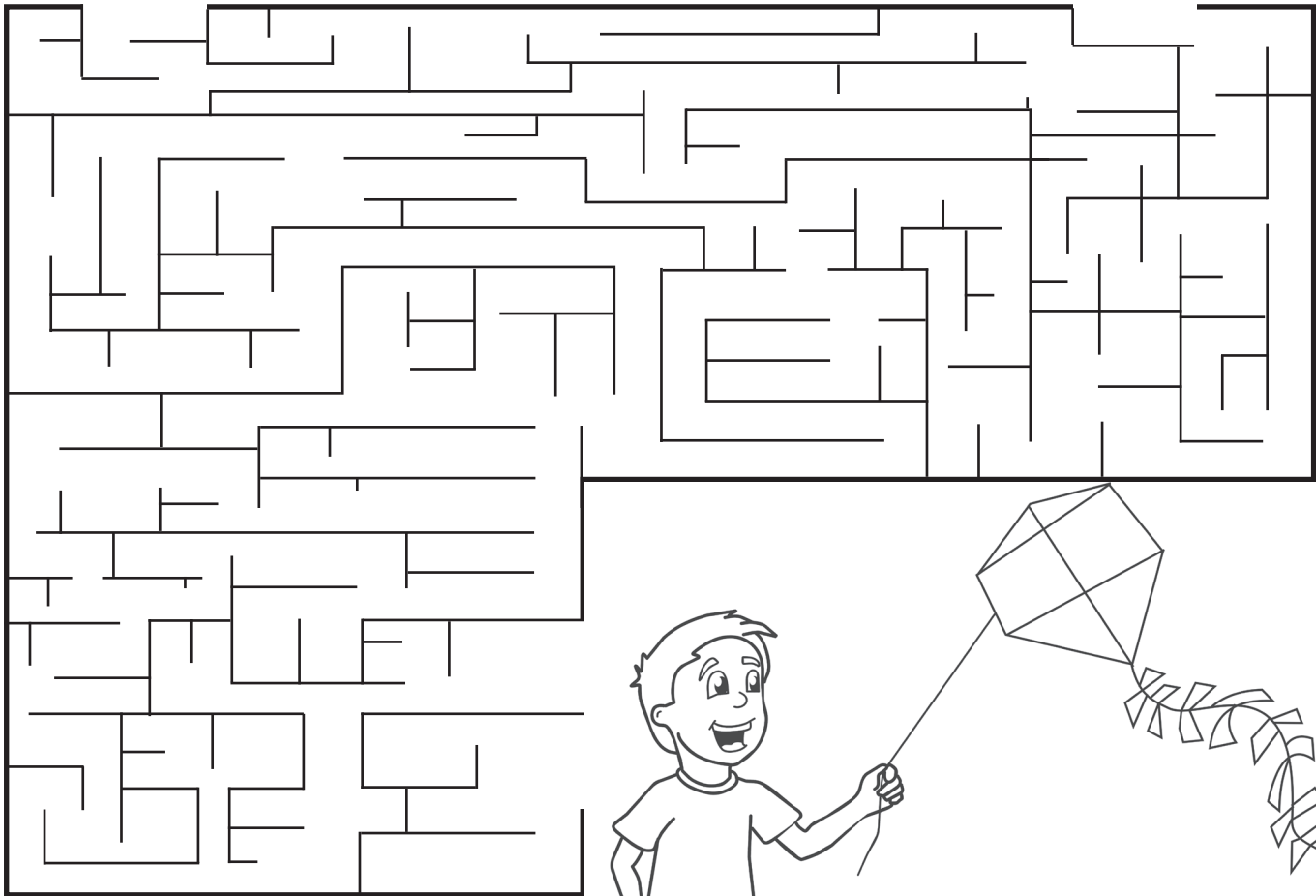
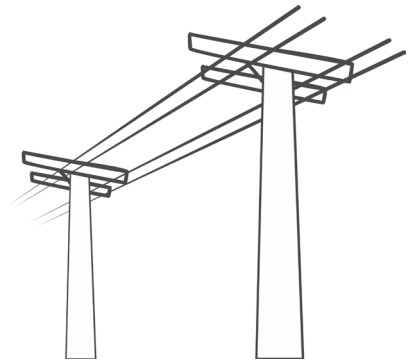
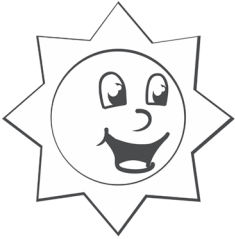



Jogo dos 7 erros

Mesmo que você seja fera nos esportes, nunca se esqueça do capacete.
Ele diminui em 85% as chances de você machucar a cabeça.
Use também cotoveleiras e joelheiras.

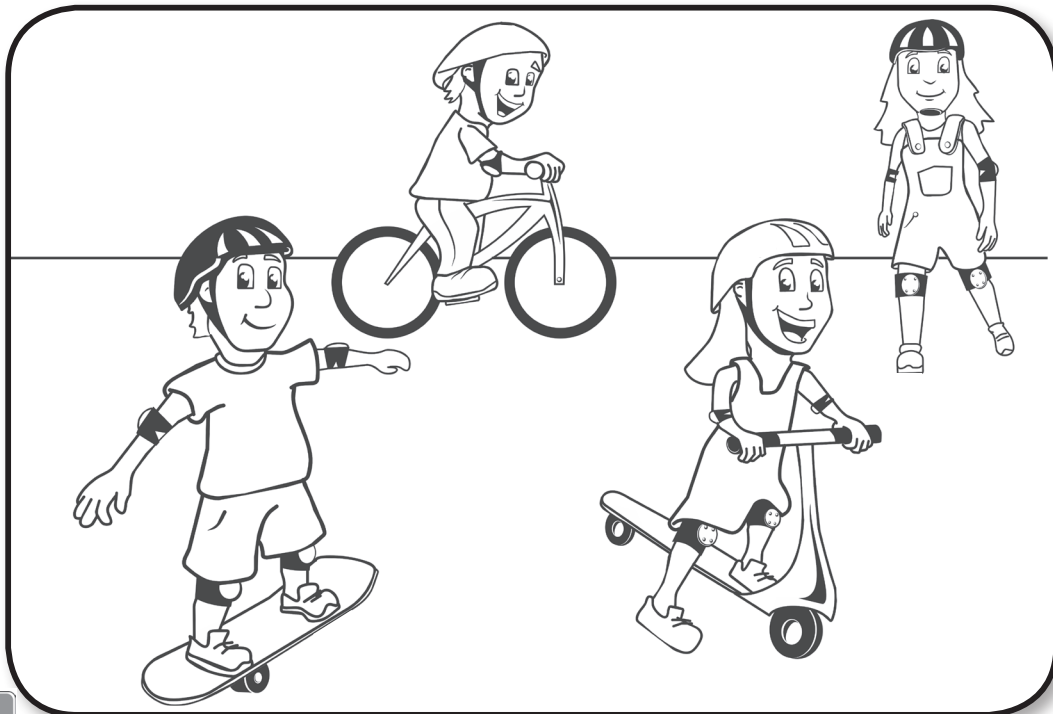
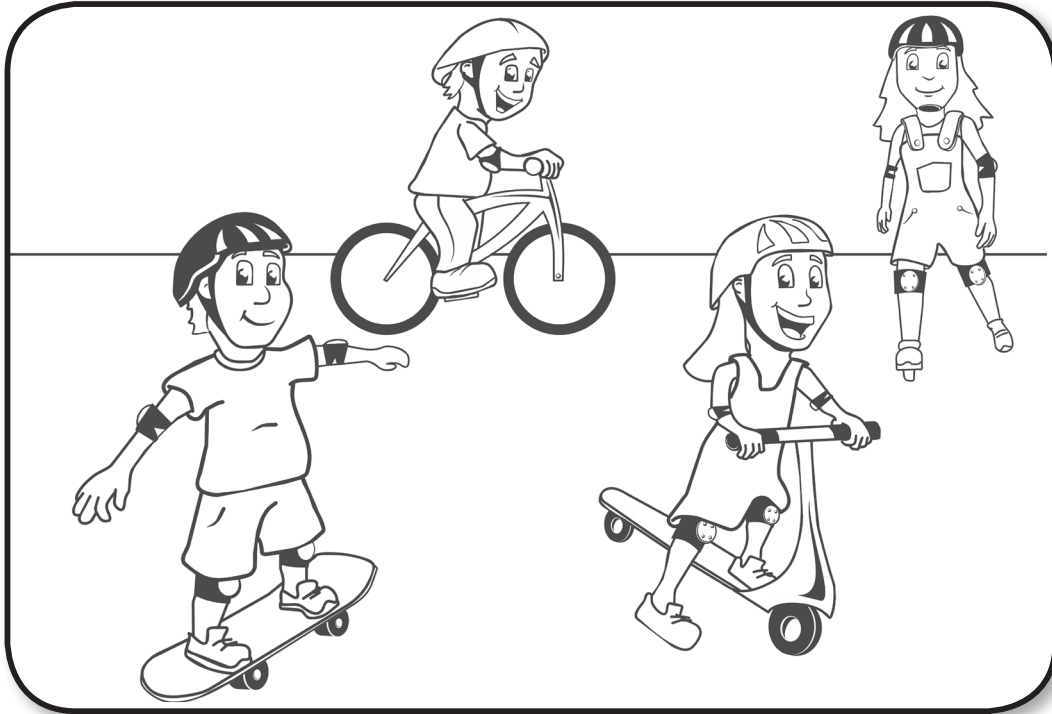



Descubra a mensagem secreta



A- ★	Ã- ☆	B- +	C- ✨	D- □	E- ☆	F- ▲
G- ☆	I- ◡	L- ✕	M- ☺	N- □	O- ✨	P- ▲
Q- ○	R- ✕	S- ◡	T- ◡	U- ◡	X- ♥	Ç- ◡

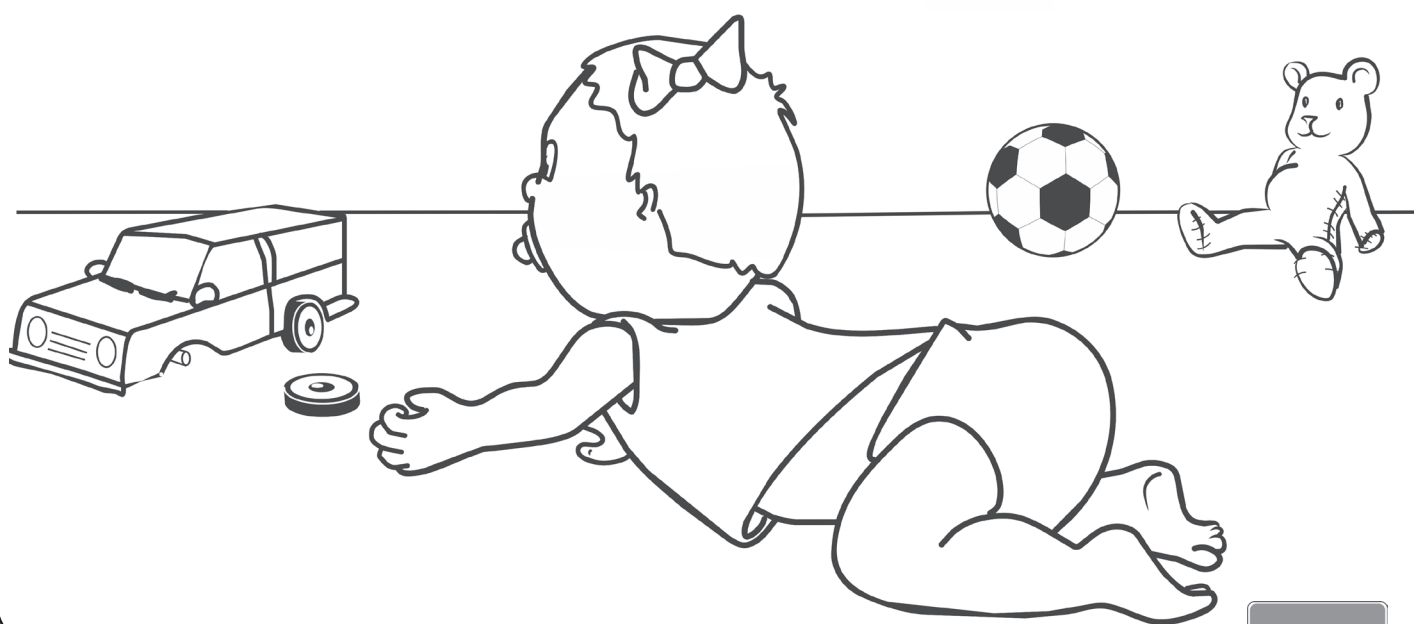



Quebra-cabeça

Até completar 7 anos e meio, as crianças devem ir no banco de trás do carro e usar dispositivo de segurança (bebê conforto até 1 ano, cadeirão até 4 anos e assento de elevação / booster até 7 anos e meio).

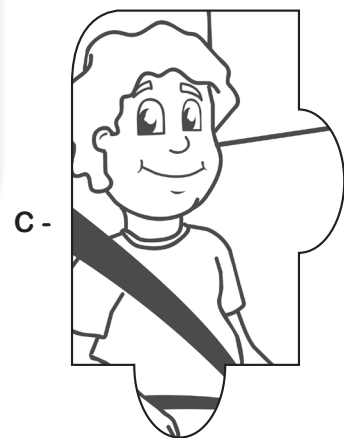
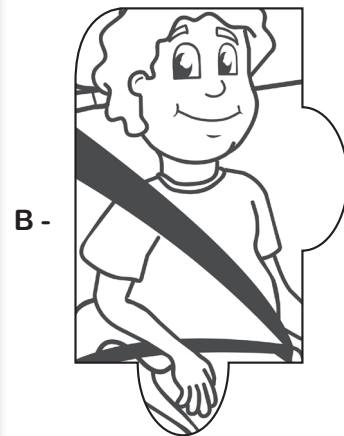
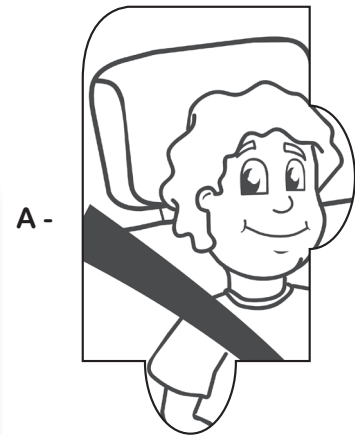
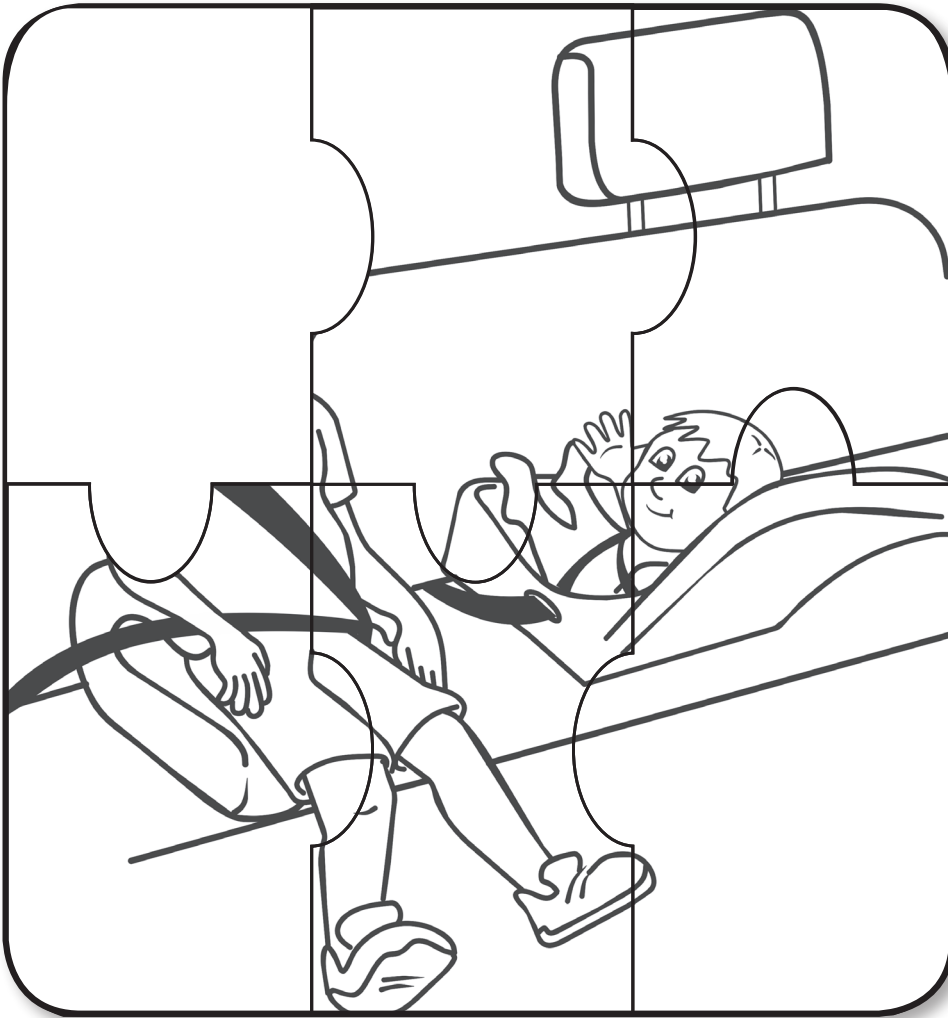



Cruzadinha

Crianças menores de 10 anos devem sempre atravessar a rua acompanhadas de um adulto
Veja outras dicas e complete a cruzadinha:

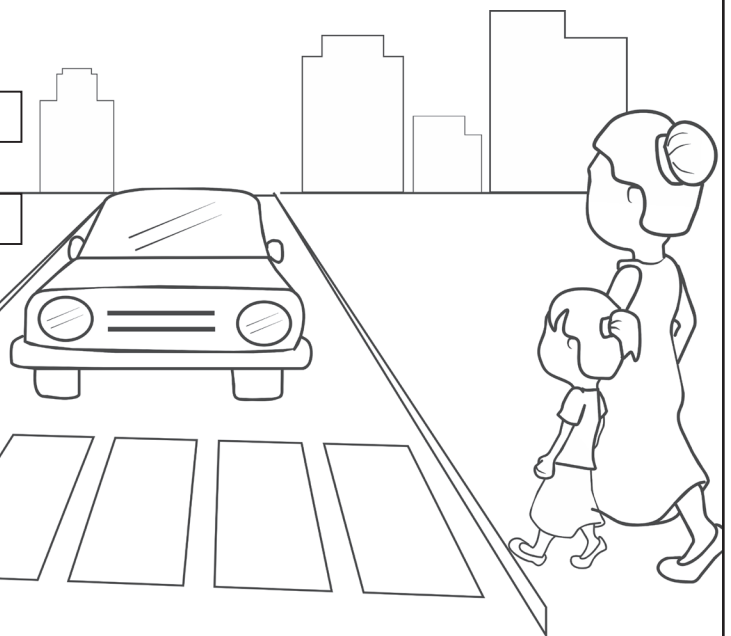
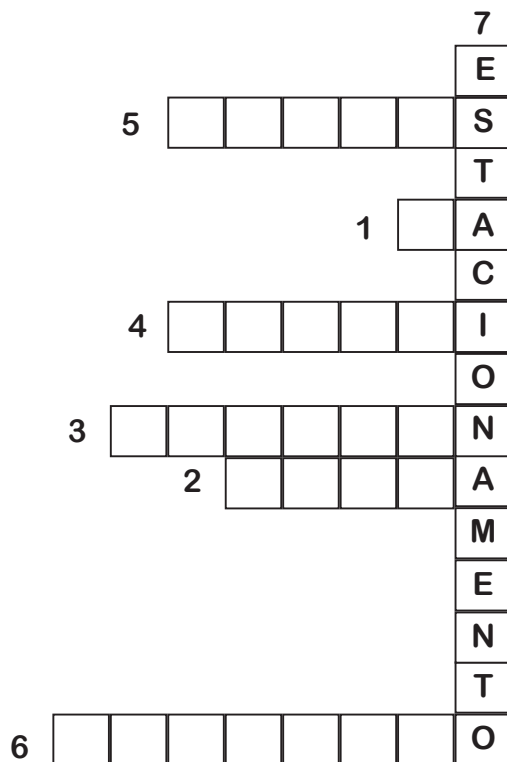

- 1-) Antes de atravessar olhe várias vezes para os dois _____.
- 2-) Caminhe sempre na _____, longe da guia.
- 3-) Atravesse a rua sempre na faixa de _____.
- 4-) Ao atravessar a rua olhe sempre para o _____ e tenha a certeza que ele te viu.
- 5-) Nunca atravesse por trás de _____ ou caminhões, eles impedem que você veja os outros carros.
- 6-) Observe sempre o _____ de pedestre. E só atravesse com ele no verde.
- 7-) Evite andar atrás dos carros no **ESTACIONAMENTO** do shopping ou supermercado. Eles podem dar ré sem você notar.



Vamos colorir de acordo com os números?

A cozinha é o lugar de maior perigo de queimaduras. Cuidado com forno quente, e lembre sua mamãe de sempre cozinhar com os cabos das panelas para o lado de dentro do fogão.

- 1 - Rosa
- 2 - Vermelho
- 3 - Amarelo
- 4 - Azul
- 5 - Marrom

- 6 - Laranja
- 7 - Verde
- 8 - Bege
- 9 - Roxo
- 10 - Cinza





Jogo das sombras

Descubra qual é a sombra correta do desenho.



A -



B -



C -



D -



E -



F -





Ligue

Ligue cada objeto à cena correta.

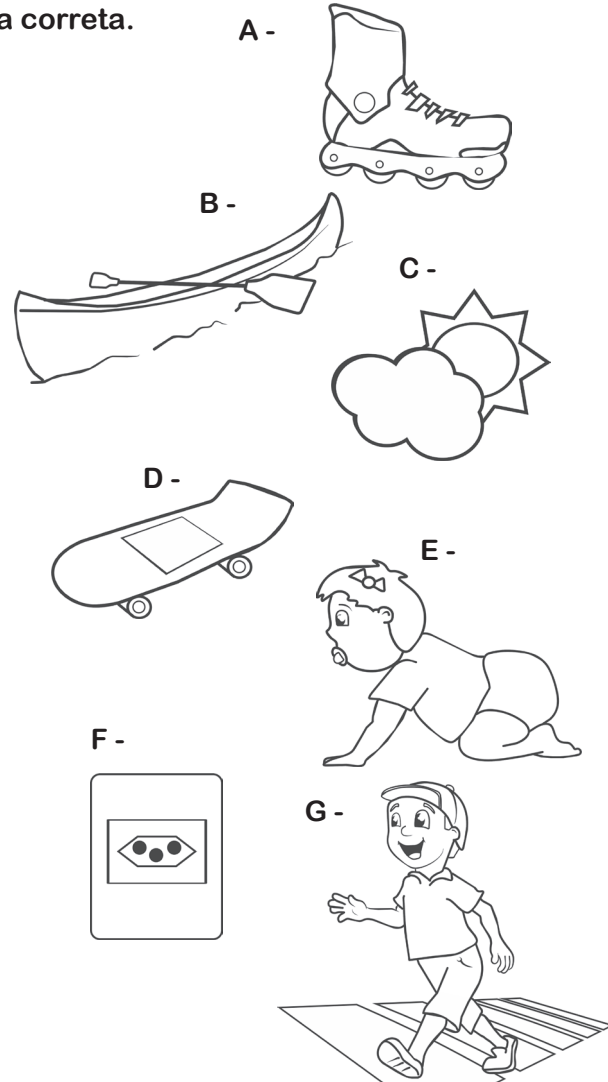
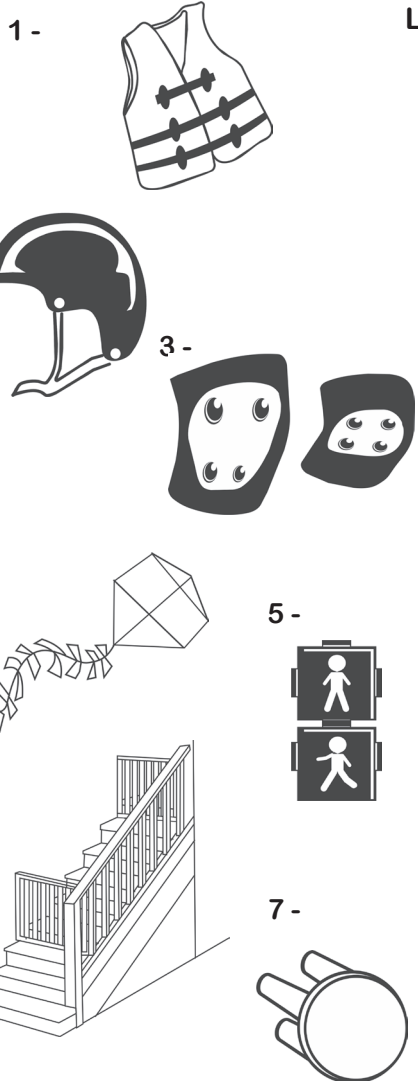

Respostas

2-

Á	Ç	R	Y	R	E	H	P	Ç	A	I	Á	R	T	A	Y	K	Ã	U
Y	E	R	A	A	H	M	F	A	G	O	Z	A	Z	I	Ã	L	A	Ç
S	E	M	A	F	O	R	O	D	E	P	E	D	E	S	T	R	E	A
Ç	A	P	B	A	O	R	U	T	X	V	C	B	N	M	Y	O	P	P
Â	R	F	A	I	X	A	D	E	S	E	G	U	R	A	N	Ç	A	A
U	O	A	D	A	A	I	B	K	L	A	R	Y	O	Ç	A	O	M	C
A	J	O	E	L	H	E	I	R	A	B	A	U	A	M	K	U	I	E
M	N	B	T	C	X	Z	L	K	J	H	G	F	D	S	A	P	Ã	T
M	A	R	E	D	E	D	E	P	R	O	T	E	Ç	Ã	O	T	O	E
Q	A	E	R	T	Y	U	I	O	P	A	S	D	E	F	G	H	J	Ç
C	O	L	E	T	E	S	A	L	V	A	V	I	D	A	S	K	P	I
U	A	H	E	S	T	O	P	C	O	T	O	V	E	L	E	I	R	A

4-

5-

6 - NUNCA DEIXE PEÇAS PEQUENAS PERTO DO SEU IRMÃO MENOR, ELE PODE POR NA BOCA E ENGASGAR

7 - A 8 - 1) Lados; 2) Calçada; 3) Segurança; 4) Motorista; 5) Ônibus; 6) Semáforo; 7) Estacionamento.

10 - E 11 - 1-B; 2-A; 3-D; 4-C; 5-G; 6-E; 7-F.

RECADO

Recadinho para mães e pais:

Vocês sabiam que os acidentes são a principal causa de morte no Brasil entre crianças de 1 a 14 anos?

Veja os principais riscos por faixa-etária:

Menor de 1 ano – sufocação

1 a 4 anos – afogamento

5 a 14 anos – acidentes de trânsito

A boa notícia é que 90% dos acidentes podem ser evitados com cuidados e prevenção. Confira as dicas revendo com seu filho as atividades do Biguccino.

Outras informações:
www.criancasegura.org.br

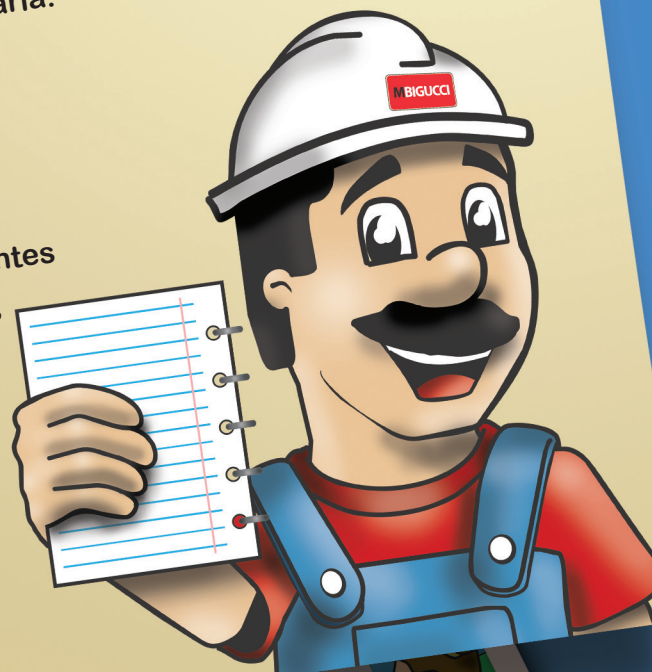

(11) 4367 - 8600



Construindo uma vida melhor

www.mbigucci.com.br